



# Cat<sup>®</sup> 6040

## Hydraulic Shovel

### Specifications

#### General Data

##### Operating weight

Face Shovel	397 tonnes	438 tons
Backhoe	397 tonnes	438 tons

##### Engine Output SAE J1995

Cat <sup>®</sup> C32	1 516 kW	2,032 HP
Cummins <sup>®</sup> KTA38C	1 492 kW	2,000 HP

##### Standard Bucket Capacity

Face Shovel (SAE 2:1)	22.0 m <sup>3</sup>	28.8 yd <sup>3</sup>
Backhoe (SAE 1:1)	22.0 m <sup>3</sup>	28.8 yd <sup>3</sup>

#### Features

- *TriPower* shovel attachment
- Independent oil cooling system
- Spacious walk-through machine house
- 5-circuit hydraulic system
- New on-board electronics system: Control and Monitoring Platform (CAMP)
- New Board Control System (BCS III)
- Torque control in closed-loop swing circuit
- Automatic central lubrication system
- Xenon working lights

#### Operating Weight

##### Shovel

Standard track pads	1 200 mm (3 ft 11 in)
Operating weight	397 400 kg (876,110 lb)
Ground pressure	23.8 N/cm <sup>2</sup> (34.4 psi)

Additional track pads available on request

##### Backhoe

Standard track pads	1 200 mm (3 ft 11 in)
Operating weight	397 000 kg (875,230 lb)
Ground pressure	23.8 N/cm <sup>2</sup> (34.4 psi)

Additional track pads available on request

#### Electrical System (diesel drive)

System voltage	24 V
Batteries	6 x 210 Ah - 12 V each
in series / parallel installation	630 Ah - 24 V in total
Working spot lights	8 x high-brightness Xenon lights

- Battery isolation relays
- Emergency stop switches accessible from ground level, in engine module and in operator's cab

# Hydraulic Shovel—6040

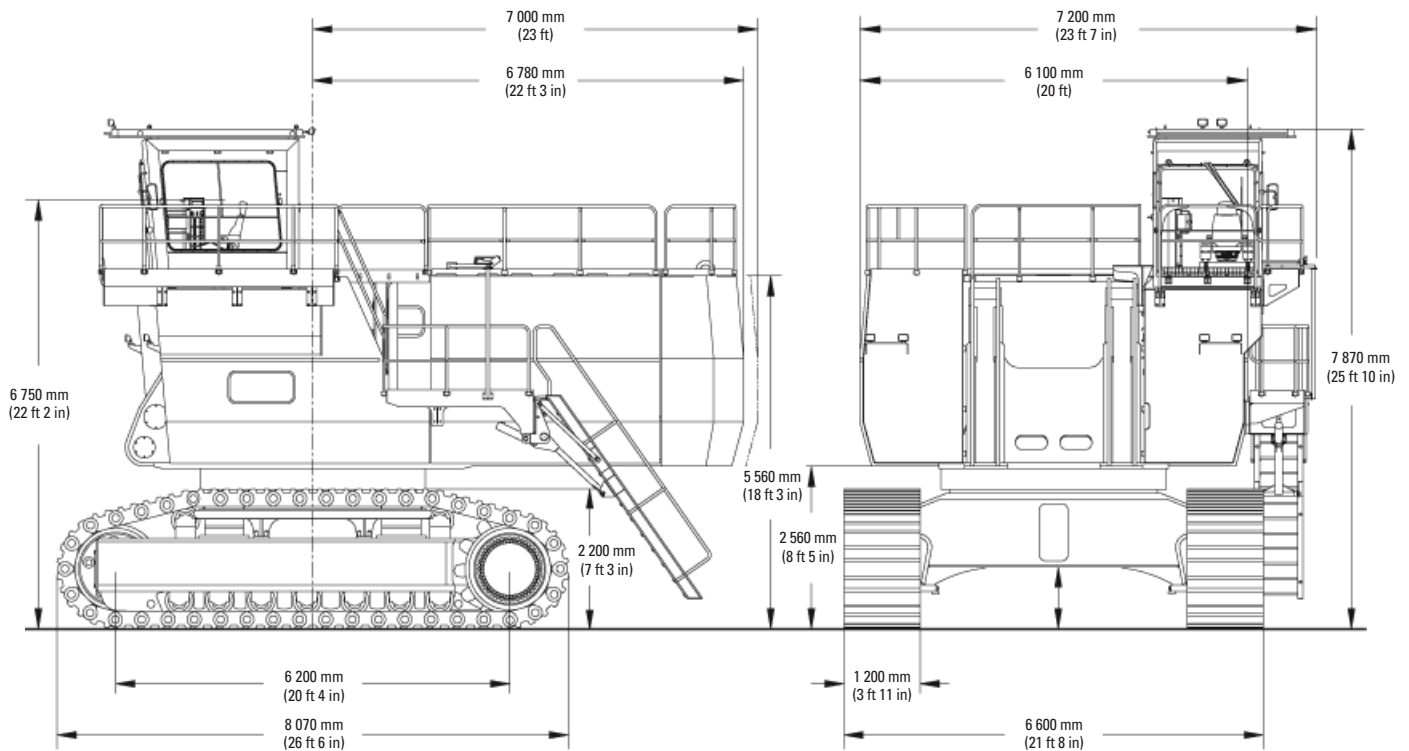

## Hydraulic Oil Cooling

Oil flow of cooling pumps

Diesel Version	2 x 799 l/min (2 x 211 US gal/min)
Electric Version	4 x 379 l/min (4 x 100 US gal/min)

Diameter of fans 2 x 1 524 mm (2 x 60 in)

- Cooling system is fully independent of all main circuits, i.e. controlled cooling capacity is available whenever engine is running
- Gear type cooling pumps supplying high-volume, low-pressure oil to aluminum coolers
- Variable axial piston pumps supplying low-volume, high-pressure oil to fans
- Fan speed is thermostatically controlled
- Extremely high cooling efficiency to ensure optimum oil temperature

## Electric Motor (optional)

Type	Squirrel cage induction motor
Output	1 400 kW
Voltage (other on request)	6.6 kV +/- 10%
Rated Current $I_N$	156 A
Frequency	50 Hz (60 Hz on request)
Revolutions (1,800 min <sup>-1</sup> at 60 Hz)	1,500 min <sup>-1</sup>
Starting current	350% of $I_N$ (260% of $I_N$ Optional)

- Custom-made electric motor with increased gap between rotor and stator to withstand severe mining conditions
- Power limit control by Pump Managing System

## Diesel Engines

### Engine Features

Fuel Tank Capacity 7 800 l (2,060 US gal)

- Hydraulically driven radiator fan with electronically controlled fan speed
- Microprocessed engine management
- Automatic rev. reduction
- Heavy-duty air filters
- Two-stage fuel filter incl. water separator
- Additional high-capacity water separator
- Pre-lube starting system (Cummins engines only)

### Version 1 - Cat® C32 Tier 2

Make and model	2 x Cat C32
Total rated net power ISO 3046/1	1 516 kW (2,032 HP) 1,750 min <sup>-1</sup>
Total rated net power SAE J1349	1,516 kW (2,032 HP) 1,750 min <sup>-1</sup>
Total rated gross power SAE J1995	1,516 kW (2,032 HP) 1,750 min <sup>-1</sup>
No. of cylinders (each engine)	12
Bore	145 mm (5.71 in)
Stroke	162 mm (6.38 in)
Displacement	32.1 l (1,959 in <sup>3</sup> )
Aspiration	Turbocharged and air-to-air aftercooled
Max. altitude without deration	at 10° C 2 500 m (8,200 ft) a.s.l.
Emission certification	US EPA Tier 4i
Alternators	2 x 150 A

# Hydraulic Shovel—6040

## Diesel Engines (continued)

### Version 2 - Cummins® KTA38C Non-Cert

Make and model	2 x Cummins KTA38C-1200
Total rated net power ISO 3046/1	1 492 kW (2,000 HP) 1,800 min <sup>-1</sup>
Total rated net power SAE J1349	1 492 kW (2,000 HP) 1,800 min <sup>-1</sup>
Total rated gross power SAE J1995	1 492 kW (2,000 HP) 1,800 min <sup>-1</sup>
No. of cylinders (each engine)	12
Bore	159 mm (6.25 in)
Stroke	159 mm (6.25 in)
Displacement	37.8 l (2,300 in <sup>3</sup> )
Aspiration	Turbocharged and aftercooled
Max. altitude without deration	3 600 m (11,800 ft) a.s.l.
Alternators	2 x 175 A

## Undercarriage

Travel speed (2 stages)	1 <sup>st</sup> stage	Max. 1.5 km/h (0.93 mph)
	2 <sup>nd</sup> stage	Max. 2.5 km/h (1.55 mph)
Max. tractive force	2 097 kN (214 t = 471,260 lb)	
Gradability of travel drives	Max. 57%	
Track pads (each side)	42	
Bottom rollers (each side)	7	
Support rollers (each side)	2 plus a skid plate in between	
Travel drives (each side)	1 planetary transmission with 2 two-stage axial piston motors	
Parking brake	Wet multiple disc brake, spring applied / hydraulically released	

- Cast double-grouser combined pad-links with bushings connected by hardened full floating pins
- All running surfaces of sprockets, idlers, rollers and track links, as well as teeth contact areas of sprocket and pad links, are hardened
- Fully hydraulic self-adjusting track tensioning system with membrane accumulator
- Automatic hydraulic retarder valve to prevent over-speed on downhill travel
- Acoustic travel alarm

## Retractable Service Station

Retractable service station installed underneath the engine module and easily accessible from ground

Equipped with:

- Quick couplings for:
  - Diesel fuel
  - Engine coolant - left / right
  - Pump transmission gear oil - left / right
  - Engine oil (oil pan) - left / right
  - Engine oil (additional tank - optional) - left / right
  - Hydraulic oil tank
  - Grease container
- Cat jump-start socket
- Indicator lights for fuel tanks left/right full and grease container full

## Hydraulic System with Pump Managing System

Main pumps	
Diesel version	4 x variable swash plate pumps
Electric version	4 x variable flow axial piston pumps
Max. oil flow	
Cat version	4 x 724 l/min (4 x 191 US gal/min)
Cummins version	4 x 745 l/min (4 x 197 US gal/min)
Electric version	4 x 746 l/min (4 x 197 US gal/min)
Max. pressure, attachment	32 MPa = 330 bar (4,640 psi)
Max. pressure, travel	37 MPa = 370 bar (5,365 psi)
Swing pumps	
Diesel version	4 x reversible swash plate pump
Electric version	3 x reversible swash plate pump
Max. oil flow	
Cat version	4 x 321 l/min (4 x 85 US gal/min)
Cummins version	4 x 331 l/min (4 x 87 US gal/min)
Electric version	3 x 491 l/min (3 x 130 US gal/min)
Max. pressure, swing circuit	33 MPa = 330 bar (4,785 psi)
Total volume of hydraulic oil	
Diesel version	Approx. 5 800 l (1,532 US gal)
Electric version	Approx. 6 400 l (1,585 US gal)
Hydraulic tank capacity	
Diesel version	Approx. 3 400 l (898 US gal)
Electric version	Approx. 4 000 l (1,057 US gal)

### • Pump Managing System contains:

- Electronic load limit control
- Flow on demand from main pumps depending on joystick position
- Automatic regulation of main pumps to zero flow without demand
- Automatic rpm reduction of engine speed during working breaks
- Reduced oil flow of main pumps at high hydraulic oil temperature or at high engine temperature

### • Pressure cut-off for main pumps

### • Cooling of pump transmission gear oil

### • Filters:

- Full-flow high-pressure filters (100 µm) for the main pumps, installed directly behind each pump
- Full-flow filters (10 µm) for the complete return circuit
- Full-flow filters (10 µm) for the cooling return circuit
- Pressure filters (6 µm) for servo circuit
- Pressure filters (40 µm) for the feed pumps of the closed swing circuit
- Transmission oil filters (40 µm)

# Hydraulic Shovel—6040

## Operator's Cab

Operator's eye level	Approx. 6.75 m (22 ft 2 in)
Internal dimensions of cab	Length: 2 200 mm (7 ft 3 in) Width: 1 600 mm (5 ft 3 in) Height: 2 150 mm (7 ft 1 in)

- Pneumatically cushioned and multi-adjustable comfort seat with lumbar support, seat heating, safety belt, head- and armrests
- Switch in seat cushion to automatically neutralize the hydraulic controls when operator leaves the seat
- Joystick controls integrated in independently adjustable seat consoles
- Fold-away auxiliary seat with safety belt
- FOPS (rock guard; approved acc. to DIN ISO 3449) integrated into cab structure
- All-round safety glass, armored windshield and sliding side window
- Windshield with parallel intermittent wiper / washer
- Roller blind at windshield
- Robust instrument panel incl. large colored BCS screen with transfective technology
- New Board Control System (BCS III); electronic monitoring, data logging and diagnostic system for vital signs and service data of engines, hydraulic system and lubrication system, featuring:
  - Robust instrument panel including large (12 in) colored touch screen for intuitive handling
  - On-screen PDF documentation (e.g. operating instructions, technical handbook, spare parts catalog, electric circuit diagram)
  - On-screen troubleshooting assistance
  - Graphic charts of logged data
  - Fault memory with storage of related conditions
  - USB, Lan (TCP/IP) and CAN BUS interfaces for data export
- Machine access via retractable boarding ladder, hydraulically operated
- Emergency exit harness kit

## Attachments

- Boom and sticks are torsion-resistant, welded box design of high-tensile steel with massive steel casting at pivot areas
- Welding procedures allow for internal counter-welding (double prep weld) wherever possible
- Boom and sticks are stress-relieved after welding
- Inspection hole in monoboam of BH-attachment
- Catwalks with rails at boom (FS and BH)
- Pressure-free lowering of boom (FS and BH) and stick (FS) by means of a float valve
- Shovel attachment with unique *TriPower* kinematics ensuring the following main features:
  - Horizontal automatic constant-angle bucket guidance
  - Vertical automatic constant-angle bucket guidance
  - Automatic roll-back limiter to prevent material spillage

## Attachments (continued)

- Kinematic assistance to hydraulic forces
- Constant boom momentum throughout the whole lift arc
- Crowd force assistance
- All buckets (FS and BH) are equipped with a universal wear package suitable for all standard applications, which consists of:
  - Special liner material covering main wear areas inside and outside of bucket
  - Lip shrouds between teeth
  - Wing shrouds on side walls
  - Heel shrouds at bottom edges
- Special wear packages for highly abrasive materials on request

## Swing System

Swing Drives	3 compact planetary transmissions with axial piston motors	
Parking Brake	Wet multiple disc brake, spring-loaded / hydraulically released	
Max. swing speed	Cat Version	4.7 rpm
	Cummins Version	4.8 rpm
	Electric Version	5.1 rpm
Swing ring	Triple-race roller bearing with sealed internal gearing	

- Closed-loop swing circuit with torque control
- Hydraulic braking of the swing motion by counteracting control
- All race ways of swing ring, as well as grease bath for internal gearing, supplied by automatic central lubrication system

## Automatic Lubrication System

Capacity of grease container	1 000 l (264 US gal)
------------------------------	----------------------

- Dual-circuit system with hydraulically driven heavy-duty pump and electronic time relay control adjust the pause / lube times
- Connected to the lubrication system are the swing roller bearing with internal gearing and all pivot points of attachment, bucket and cylinders
- System failures displayed by Board Control System
- Grease filters (200 µm) between service station and container, as well as directly behind grease pump

# Hydraulic Shovel—6040

## TriPower Face Shovel Attachment (FS)

Working Diagram - Boom 7.3 m (23 ft 11 in) - Stick 4.6 m (15 ft 1 in)

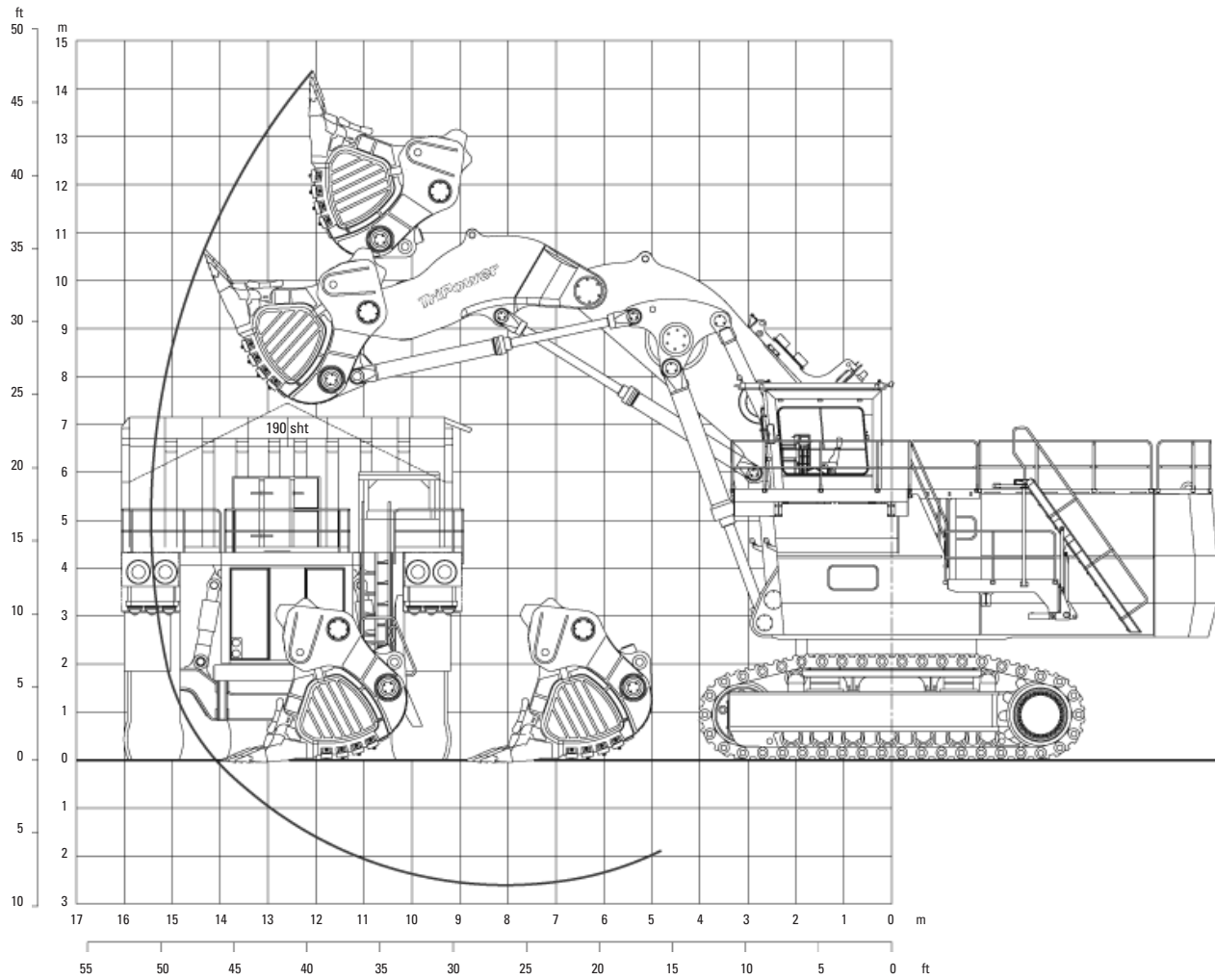

### Working Range

Max. digging height	14.4 m	47 ft 3 in
Max. digging reach	15.4 m	50 ft 6 in
Max. digging depth	2.6 m	8 ft 6 in
Max. dumping height	10.9 m	35 ft 9 in
Crowd distance on level	5.1 m	16 ft 9 in

### Digging Forces

Max. crowd force	1 810 kN	406,760 lb
Max. crowd force at ground level	1 280 kN	287,650 lb
Max. breakout force	1 270 kN	285,410 lb

### Face Shovels

Type	Iron ore shovel	Heavy rock shovel	Heavy rock shovel	Standard rock shovel
Tooth system	ESCO S110	ESCO S110	ESCO S110	ESCO S110
Capacity SAE / PCSA 1:1	17.1 m <sup>3</sup> (22.4 yd <sup>3</sup> )	20.6 m <sup>3</sup> (26.9 yd <sup>3</sup> )	23.2 m <sup>3</sup> (30.3 yd <sup>3</sup> )	25.3 m <sup>3</sup> (33.1 yd <sup>3</sup> )
<b>Capacity SAE / CECE 2:1</b>	<b>15.0 m<sup>3</sup> (19.6 yd<sup>3</sup>)</b>	<b>18.0 m<sup>3</sup> (23.5 yd<sup>3</sup>)</b>	<b>20.0 m<sup>3</sup> (26.2 yd<sup>3</sup>)</b>	<b>22.0 m<sup>3</sup> (28.8 yd<sup>3</sup>)</b>
Total width	4 220 mm (13 ft 4 in)	4 220 mm (13 ft 4 in)	4 680 mm (15 ft 4 in)	4 680 mm (15 ft 4 in)
Inner width	3 840 mm (12 ft 7 in)	3 840 mm (12 ft 7 in)	4 300 mm (14 ft 1 in)	4 300 mm (14 ft 1 in)
Opening width	1 940 mm (6 ft 4 in)	1 940 mm (6 ft 4 in)	2 010 mm (6 ft 7 in)	2 010 mm (6 ft 7 in)
No. of teeth	5	5	6	6
Weight incl. universal wear kit	33 600 kg (74,070 lb)	34 300 kg (75,620 lb)	36 300 kg (80,030 lb)	37 300 kg (82,230 lb)
Max. material density (loose)	2.8 t/m <sup>3</sup> (4,720 lb/yd <sup>3</sup> )	2.2 t/m <sup>3</sup> (3,710 lb/yd <sup>3</sup> )	2.0 t/m <sup>3</sup> (3,370 lb/yd <sup>3</sup> )	1.8 t/m <sup>3</sup> (3,030 lb/yd <sup>3</sup> )

# Hydraulic Shovel—6040

## Backhoe Attachment (BH)

Working Diagram - Boom 9.5 m (31 ft 2 in) - Stick 4.6 m (15 ft 1 in)

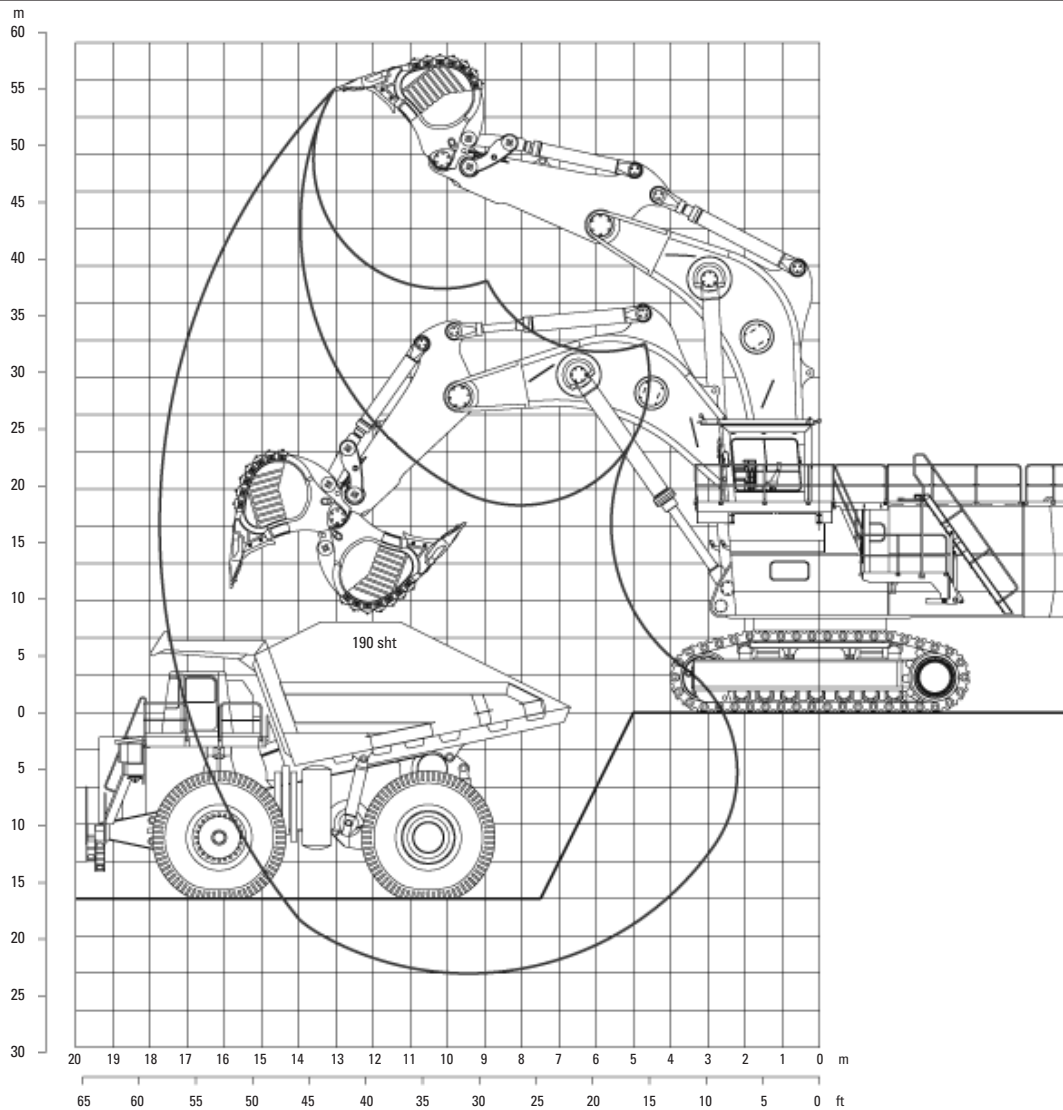

### Working Range

Max. digging depth	7.0 m	23 ft
Max. digging reach	17.7 m	58 ft 1 in
Max. digging height	16.8 m	55 ft 1 in

### Digging Forces

Max. crowd force	1 070 kN	240,460 lb
Max. breakout force	1 120 kN	251,700 lb

### Backhoes

Type	Heavy rock bucket	Heavy rock bucket	Standard rock bucket
Tooth system	ESCO S95	ESCO S95	ESCO S95
<b>Capacity SAE 1:1</b>	<b>18.0 m<sup>3</sup> (23.5 yd<sup>3</sup>)</b>	<b>20.0 m<sup>3</sup> (26.2 yd<sup>3</sup>)</b>	<b>22.0 m<sup>3</sup> (28.8 yd<sup>3</sup>)</b>
Capacity CECE 2:1	16.1 m <sup>3</sup> (21.1 yd <sup>3</sup> )	17.7 m <sup>3</sup> (23.2 yd <sup>3</sup> )	19.5 m <sup>3</sup> (25.5 yd <sup>3</sup> )
Capacity struck	14.0 m <sup>3</sup> (18.3 yd <sup>3</sup> )	15.3 m <sup>3</sup> (20.0 yd <sup>3</sup> )	17.2 m <sup>3</sup> (22.5 yd <sup>3</sup> )
Total width	4 150 mm (13 ft 7 in)	4 150 mm (13 ft 7 in)	4 150 mm (13 ft 7 in)
Inner width	3 800 mm (12 ft 6 in)	3 800 mm (12 ft 6 in)	3 800 mm (12 ft 6 in)
No. of teeth	6	6	6
Weight incl. universal wear kit	21 000 kg (46,300 lb)	22 600 kg (49,820 lb)	23 800 kg (52,470 lb)
Max. material density (loose)	2.2 t/m <sup>3</sup> (3,710 lb/yd <sup>3</sup> )	2.0 t/m <sup>3</sup> (3,370 lb/yd <sup>3</sup> )	1.8 t/m <sup>3</sup> (3,030 lb/yd <sup>3</sup> )

# Hydraulic Shovel—6040

## General Packing List

### Crawler side frame (2 units)

Width 1 800 mm (5 ft 11 in) Gross weight 29 950 kg (66,030 lb)

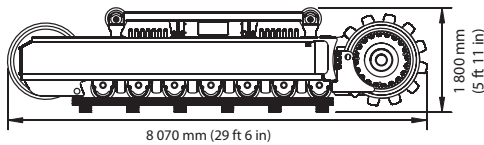

### 6 tracks consisting of 13 pad links each

Width 1 200 mm (4 ft 7 in) Gross weight (each) 7 350 kg (16,200 lb)



### Superstructure center frame

Width 3 610 mm (11 ft 10 in) Gross weight 50 500 kg (111,330 lb)

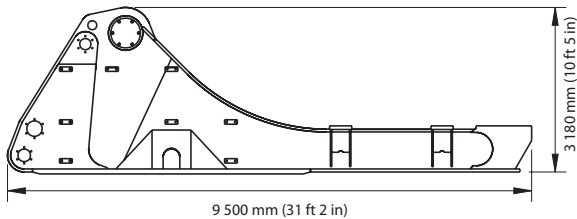

### Cab pedestal module

Width 2 500 mm (8 ft 2 in) Gross weight 7 100 kg (15,650 lb)

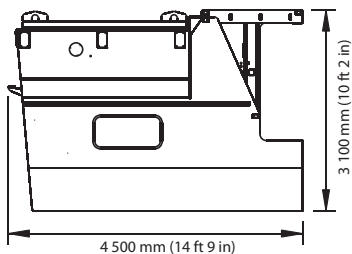

### Crate with cabin and FOPS

Width 2 610 mm (8 ft 7 in) Gross weight 3 800 kg (8,380 lb)

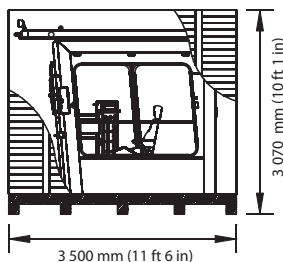

### Crates

Content	Length	Width	Height	Gross Weight
Three swing gear	1 550 mm (5 ft 1 in)	1 350 mm (4 ft 5 in)	1 980 mm (6 ft 6 in)	3 830 kg (8,440 lb)
Swing ring cover	2 200 mm (7 ft 3 in)	1 300 mm (4 ft 3 in)	1 150 mm (3 ft 9 in)	340 kg (750 lb)
Bolts, ladder, platform, etc.	3 400 mm (11 ft 2 in)	1 250 mm (4 ft 1 in)	1 370 mm (4 ft 6 in)	1 700 kg (3,750 lb)
Grease container with pump	1 700 mm (5 ft 7 in)	1 370 mm (4 ft 6 in)	2 160 mm (7 ft 1 in)	1 470 kg (3,240 lb)
Barrels (hydraulic oil)	1 900 mm (6 ft 3 in)	1 300 mm (4 ft 3 in)	1 270 mm (4 ft 2 in)	1 500 kg (3,310 lb)
Barrels (oil; grease; antifreeze)	2 500 mm (8 ft 2 in)	1 300 mm (4 ft 3 in)	1 270 mm (4 ft 2 in)	1 500 kg (3,310 lb)
Retractable ladder	5 570 mm (18 ft 3 in)	1 110 mm (3 ft 8 in)	1 660 mm (5 ft 5 in)	740 kg (1,630 lb)

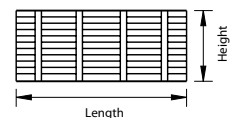

Above values are approximate. Details may vary depending on scope of supply and destination. Exact data subject to selected machine configuration and final packing list.

### Undercarriage center frame with swing roller bearing

Width 3 800 mm (12 ft 6 in) Gross weight 33 900 kg (74,740 lb)

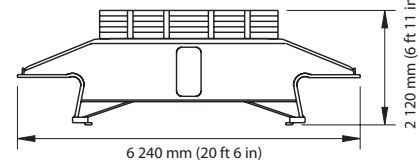

### Engine module with diesel engines

Width 6 150 mm (20 ft 2 in) Gross weight C32 33 000 kg (72,750 lb)  
KTA38 35 000 kg (77,160 lb)

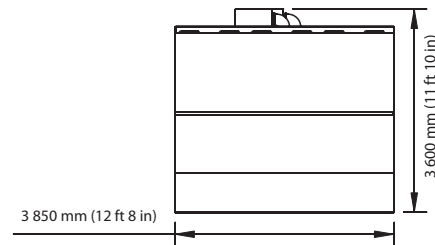

### Oil cooler module

Width 2 000 mm (6 ft 7 in) Gross weight 7 000 kg (15,430 lb)

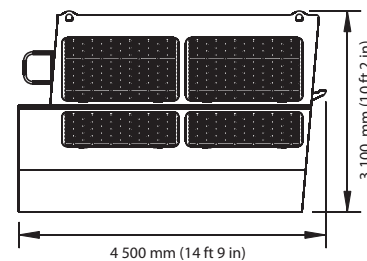

### Counterweight incl. radiators

Width 1 300 mm (4 ft 3 in) Gross weight 38 850 kg (85,650 lb)

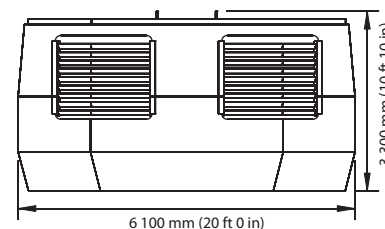

# Hydraulic Shovel—6040

## TriPower Shovel Attachment

### Boom with main valve block, TriPower linkages and rods

Width 2 800 mm (9 ft 2 in) Gross weight 35 900 kg (79,850 lb)

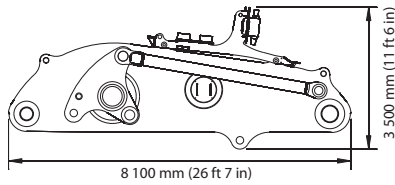

### Face shovel incl. pin for stick

Capacity (2:1)	Width	Gross weight
22.0 m <sup>3</sup> (28.8 yd <sup>3</sup> )	4 700 mm (15 ft 5 in)	38 300 kg (84,440 lb)
15.0 m <sup>3</sup> (19.6 yd <sup>3</sup> )	4 250 mm (13 ft 11 in)	34 600 kg (76,280 lb)

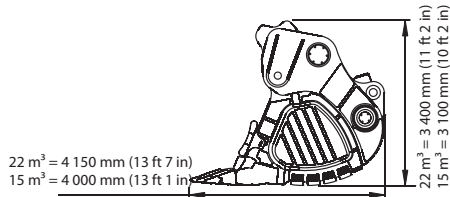

### Bundle with 2 boom cylinders

Width 1 100 mm (3 ft 7 in) Gross weight 6 700 kg (14,770 lb)

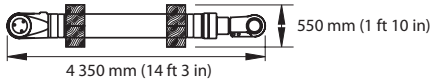

## Backhoe Attachment

### Monoboam without main valve block

Width 4 500 mm (14 ft 9 in) Gross weight 34 900 kg (76,940 lb)

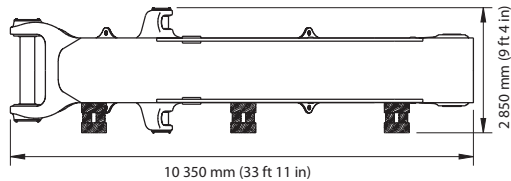

### Backhoe bucket incl. pins for stick and linkage

Capacity (2:1)	Width	Gross weight
22.0 m <sup>3</sup> (28.8 yd <sup>3</sup> )	4 310 mm (14 ft 2 in)	24 800 kg (54,670 lb)

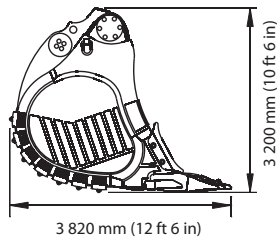

### Bundle with 2 boom cylinders

Width 1 200 mm (3 ft 11 in) Gross weight 9 600 kg (21,160 lb)

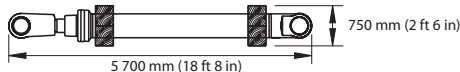

Above values are approximate. Details may vary depending on scope of supply and destination. Exact data subject to selected machine configuration and final packing list.

## Stick

Width 2 050 mm (6 ft 9 in) Gross weight 12 660 kg (27,910 lb)

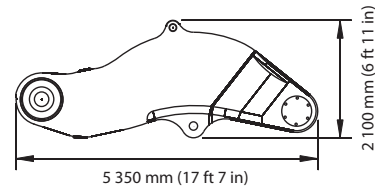

## Crates with catwalks, railings and other parts

Length	Width	Height	Gross weight
4 270 mm (14 ft)	1 900 mm (6 ft 3 in)	1 680 mm (5 ft 6 in)	2 700 kg (5,950 lb)
5 000 mm (6 ft 5 in)	1 270 mm (4 ft 2 in)	1 750 mm (5 ft 9 in)	2 900 kg (4,630 lb)

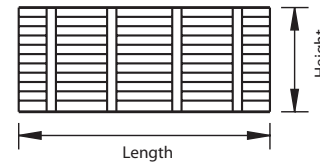

## 2 Bundles with 2 stick cylinders and 2 bucket cylinders each

Width 1 100 mm (3 ft 7 in) Gross weight 4 300 kg (9,480 lb)

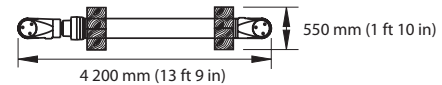

## Stick with linkage and bucket cylinders

Width 2 200 mm (7 ft 3 in) Gross weight 23 000 kg (50,710 lb)

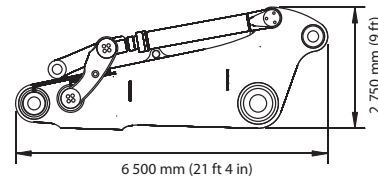

## Crates with main valve block, catwalks, railings and other parts

Length	Width	Height	Gross weight
4 950 mm (16 ft 3 in)	2 100 mm (6 ft 11 in)	1 720 mm (5 ft 8 in)	5 300 kg (27,580 lb)
4 960 mm (16 ft 3 in)	1 900 mm (6 ft 3 in)	1 840 mm (6 ft)	3 000 kg (6,610 lb)
4 260 mm (14 ft)	1 900 mm (6 ft 3 in)	1 700 mm (5 ft 7 in)	2 700 kg (11,350 lb)

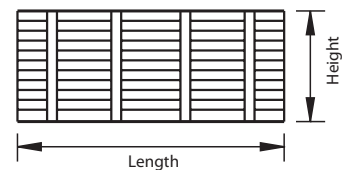

## Bundle with 2 stick cylinders

Width 1 200 mm (3 ft 11 in) Gross weight 6 400 kg (14,110 lb)

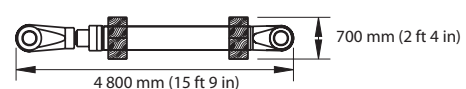



# Hydraulic Shovel—6040

## Component Accessibility on Superstructure

- |   |                   |                                   |                     |
|---|-------------------|-----------------------------------|---------------------|
| 1. Diesel engines                                 | 4. Oil coolers    | 7. Rotary Distributor             | 10. Operator's seat |
| 2. Gearboxes with hydraulic pumps                 | 5. Hydraulic tank | 8. Travel values                  | 11. BCS tower       |
| 3. Engine radiators with hydraulically driven fan | 6. Swing drives   | 9. Switch cabinet and battery box | 12. Auxiliary seat  |

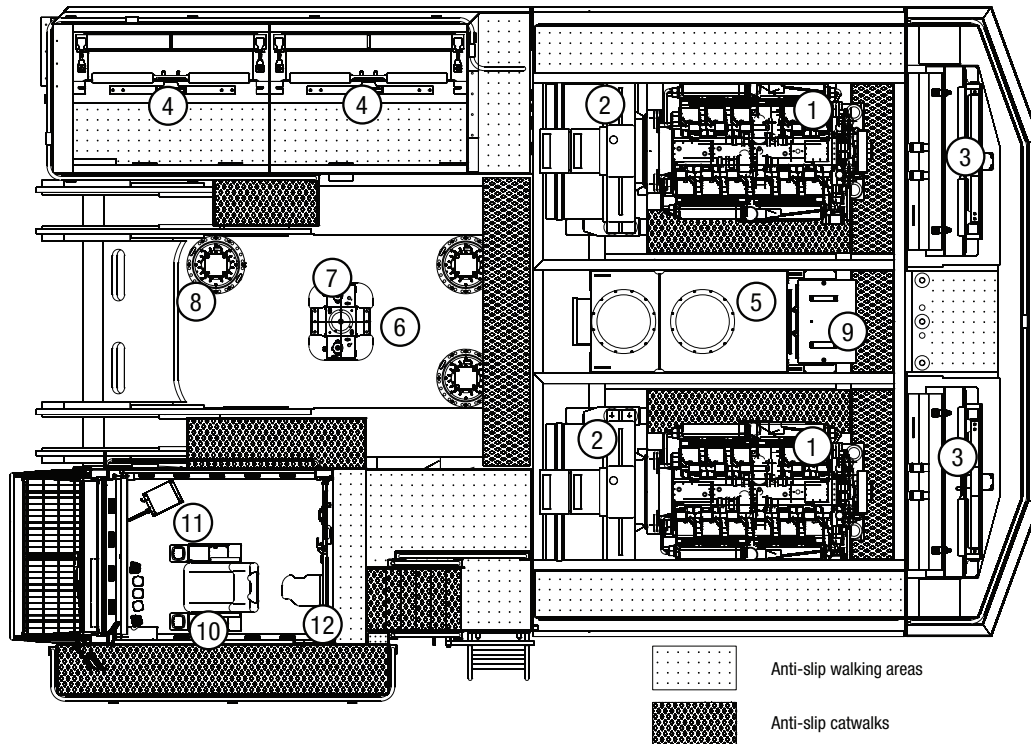

## Optional Equipment

### General

- Export crating
- Finishing as per end user's corporate colors
- Customizing of logos as per customer's specification

### Superstructure

- Hydraulic service crane on superstructure with auxiliary engine
- Mesabi radiators instead of standard radiators (Cummins engines only)
- Oil change interval extension for engine oil up to 1,000 hrs (Cummins only)
- Engine oil burn system (Cummins engines only)
- Centrifuges for engine oil filtration (Cummins engines only)
- Folding access stairway, stairway angle approx. 45°
- Round container with a standard 200 l grease barrel (instead of 1 000 l grease container)
- Lubricated pinion for greasing of internal gearing of swing ring
- Various cold-weather packages

### Cab

- Various heating and air conditioning systems
- Roller blinds at all windows
- Outside-mounted sun shields
- Additional instrumentation

### Undercarriage

- Track pad width 1 400 mm (4 ft 7 in) or 1 600 mm (5 ft 3 in)
- Automatic lubrication of rollers by central lube system
- Cover plate under carbody (belly plate)

### Attachment

- Xenon lighting on boom
- Special wear packages

Additional optional equipment available on request

**ZEPPELIN**

# ZEPPELIN – GANZ IN IHRER NÄHE

## ZEPPELIN IN IHRER NÄHE

Mit unseren rund 40 Niederlassungen in Deutschland und Österreich sind wir immer in der Nähe Ihres Standortes oder Ihrer Baustelle. Der Zeppelin Service steht Ihnen rund um die Uhr zur Verfügung. Wir liefern 98 % aller Ersatzteile innerhalb von 24 Stunden.



## ZEPPELIN DIGITAL



**ZEPPELIN SHOP**  
**KONFIGURATOR**  
**BAGGERBÖRSE**  
**KUNDENPORTAL**



Günstige Finanzierungen  
für alle unsere Maschinen  
über unseren  
Partner Cat Financial.  
**Schnell. Einfach. Flexibel.**  
**Individuell.**

Zeppelin Baumaschinen GmbH  
Graf-Zeppelin-Platz 1 · 85748 Garching bei München  
Tel. 089 32000-0 · [zeppelin-cat@zeppelin.com](mailto:zeppelin-cat@zeppelin.com)  
[zeppelin-cat.de](http://zeppelin-cat.de)

Zeppelin Österreich GmbH  
Zeppelinstraße 2 · 2401 Fischamend bei Wien  
Tel. 02232 790-0 · [info.at@zeppelin.com](mailto:info.at@zeppelin.com)  
[zeppelin-cat.at](http://zeppelin-cat.at)

For more complete information on Cat products, dealer services, and industry solutions, visit us on the web at [mining.cat.com](http://mining.cat.com) and [www.cat.com](http://www.cat.com)

© 2011 Caterpillar Inc.  
All rights reserved

CAT, CATERPILLAR, their respective logos, "Caterpillar Yellow" and the "Power Edge" trade dress, as well as corporate and product identity used herein, are trademarks of Caterpillar and may not be used without permission.

AEHQ6524

